

# Devon&Devon

## SWANSEA 16

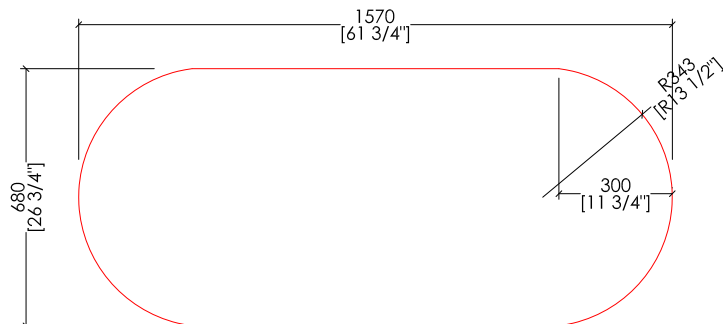

MM 1570X680:  
MISURA CONSIGLIATA PER L'INCASSO/  
INCH 61 3/4" x 26 3/4"  
RECOMMENDED SIZE OF HOLE FOR MARBLE

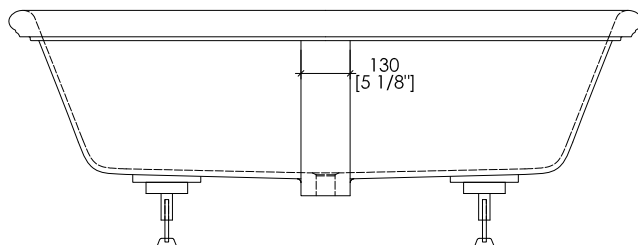
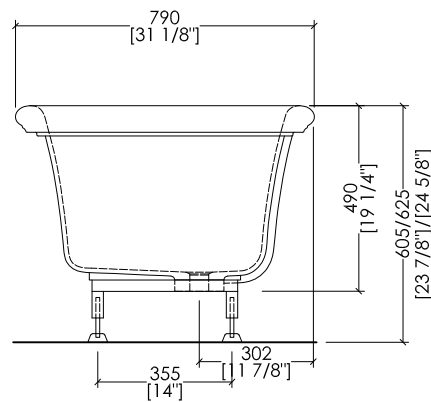
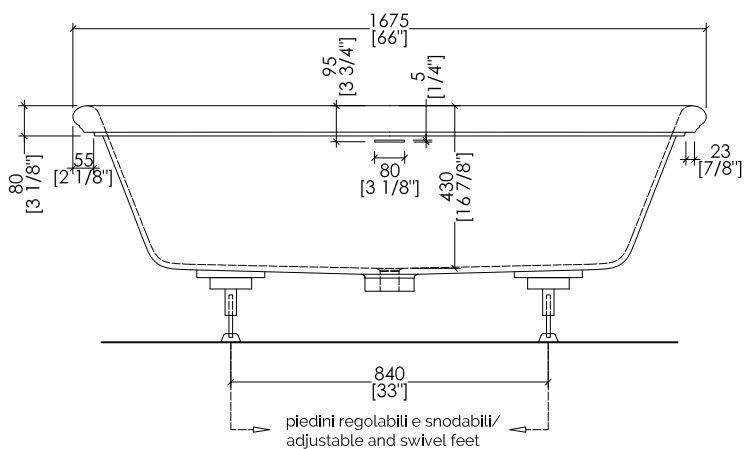
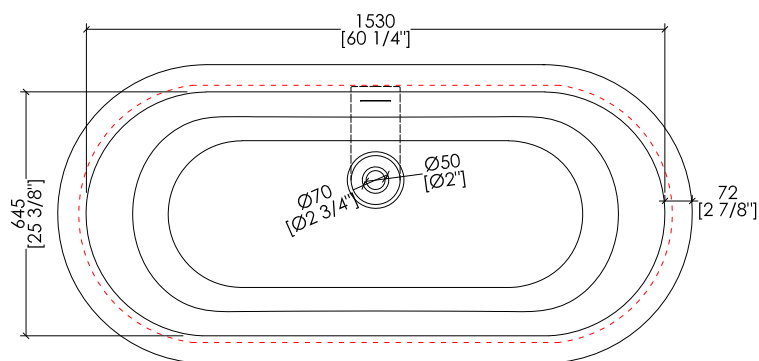

02|2020

SWANSEA16

> VASCA DA INCASSO

MATERIALE: white tec

FINITURA: bianco

> TOLLERANZA: ± 2 %

> DIMENSIONE IMBALLO: mm 1900x980x900 H

> PESO NETTO: 70 Kg

> PESO LORDO: 106 Kg

> VOLUME: 220 L > considerando il limite di capienza al troppopieno

N.B. Tutte le misure sono in millimetri/pollici. Questo disegno è di proprietà Devon&Devon. Non può essere riprodotto o trasmesso a terzi senza autorizzazione.

> INSET BATHTUB

MATERIAL: white tec

FINISH: white

> TOLERANCE: ± 2 %

> PACKAGING SIZE: inch 74 3/4" x 38 5/8" x 35 3/8" H

> NET WEIGHT: 154 Lbs

> GROSS WEIGHT: 233 Lbs

> VOLUME: 58 Gal > considering the capacity of the water to the overflow

N.B. All measurements are in millimetres/inch. This drawing is property of Devon&Devon. It may not be reproduced or transmitted to third parties without authorization.